



“ We took
IN THE
Breathtaking
VIEW
as the sun set over the horizon. ”



Memories begin with Bailey.

“Running
THROUGH THE
*country*side
ON OUR LATEST
ADVENTURE.”



Wonderful MEMORIES start here.

Memories begin with Bailey	2
Advance	4
Autograph	16
A pleasure to drive	28
Which motorhome suits you?	30
A little bit about Bailey	32
Designed with you in mind	34
Manufacturing in Bristol	36
Our technology	38
Bailey parts and accessories	40
How to buy a Bailey	42
Join the club	44

“ Planning our
NEXT
expedition
in the city sun.”



Getting way off the beaten track

Memories are what make life worth living. And with a Bailey motorhome, you're free to get out and discover new memories whenever you like. Whatever the time of day, whatever the weather, the world is waiting for you. You could be making some extra special memories very soon...



Feeling as free as a bird

When you realise you don't need to follow the map, but just go where the road takes you, pulling over on the way to marvel at an incredible view. Then you arrive at a magical destination that you weren't expecting at all. Every moment in a Bailey motorhome becomes a memory to look back on.



“Enjoying a moment of
peace and
QUIET
 in the middle of
 NOWHERE.”

Make precious
memories
 with a Bailey **APPROACH
 ADVANCE**

Life is about the journey. So take your own route and make your own way. With a Bailey Advance, you're free to go wherever and whenever the fancy takes you, getting out and about to collect some memories that will last a lifetime.



Whether you've done it before, or you're new to motorhome holidays, there's no better way to introduce yourself to the true freedom of the open road than the Bailey Advance. With comfort and convenience aplenty, you'll wonder how you ever travelled any other way.

So where will your first journey take you? To a sheltered cove, an enchanted forest, or a vibrant market town? You could be there in no time – all you have to do is get in and drive.

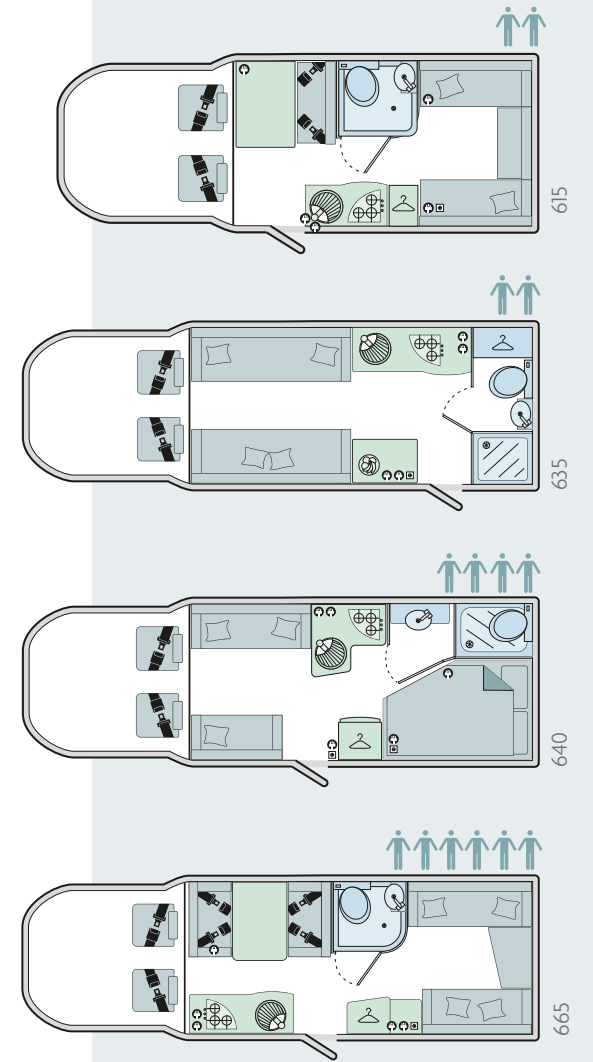



Go to: www.baileyofbristol.co.uk

360°
VIEW



“ Spending
lazy
AFTERNOONS
by the
LAKE! ”

There's no need to plan, just go. Motorhomes make the journey so much easier. We've taken that philosophy and applied it to every last detail in the Bailey Advance.

From under-floor storage through to overhead lockers, low-level night lights to soft, tactile upholstery, the Advance gives you everything you need at your fingertips. So you can take it easy as you go and then relax and unwind once you've arrived.



APPROACH
ADVANCE



Great drivability with AL-KO AMC chassis



Bailey 'Mendip Ash' furniture finish



'Pimlico' upholstery fabric



Fully adjustable upholstered driver and passenger seats



Fully equipped kitchen including Thetford three-burner gas hob and Duplex anti-rattle combination oven and grill

Go to: www.baileyofbristol.co.uk

360°
VIEW

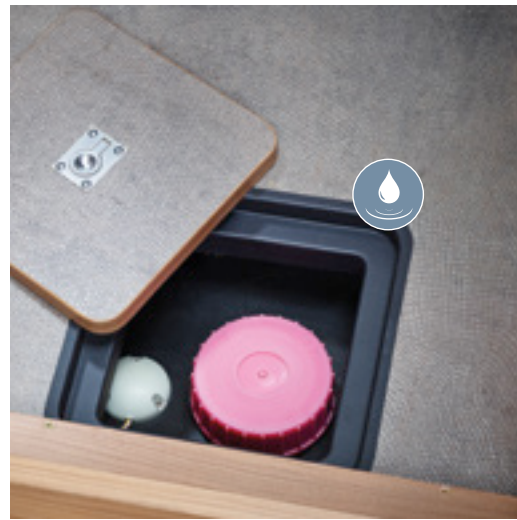
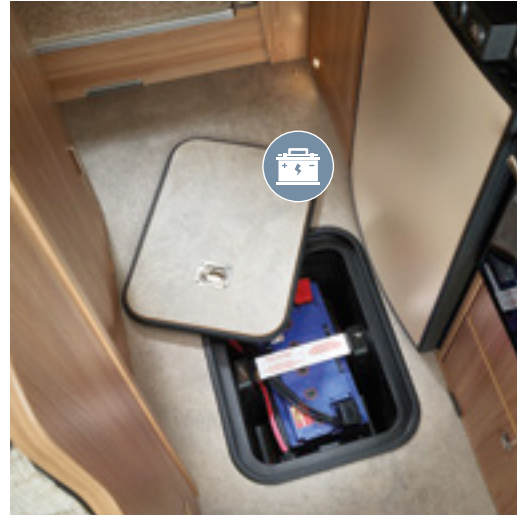

Go to: www.baileyofbristol.co.uk

360°
VIEW

Nothing should stop you from getting out there and exploring. Certainly not the weather. Your Bailey Advance comes with a rapid interior heating system to keep you cosy and warm inside, whatever's going on outside.

There's an ultra-fast Whale hot water heating system too, so you can quickly feel refreshed and reinvigorated after a day out in the open air. Once you're showered, why not prepare your favourite meal and sit down to gaze out at the scenery as you wait for it to cook.

-  80Ah leisure battery, to give greater independence away from mains power
-  90 litre on-board fresh water tank
-  Italian design overhead locker doors with a dual-finish and push button catches
-  Heki roof lights throughout
-  Fully equipped washroom with fully lined shower with Eccocamel shower head

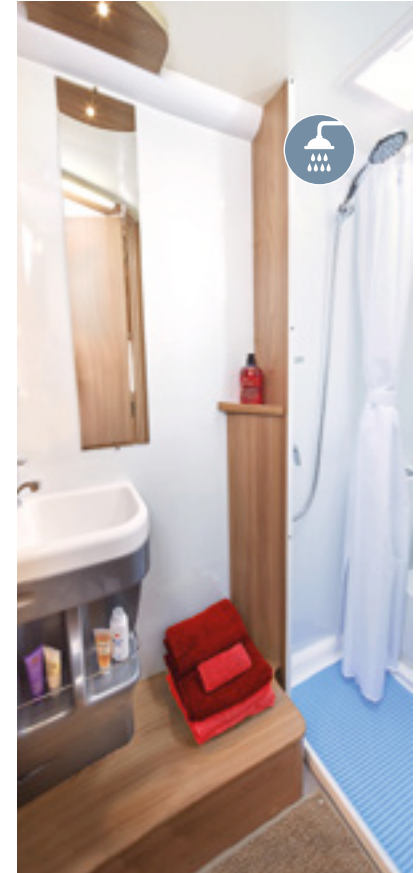

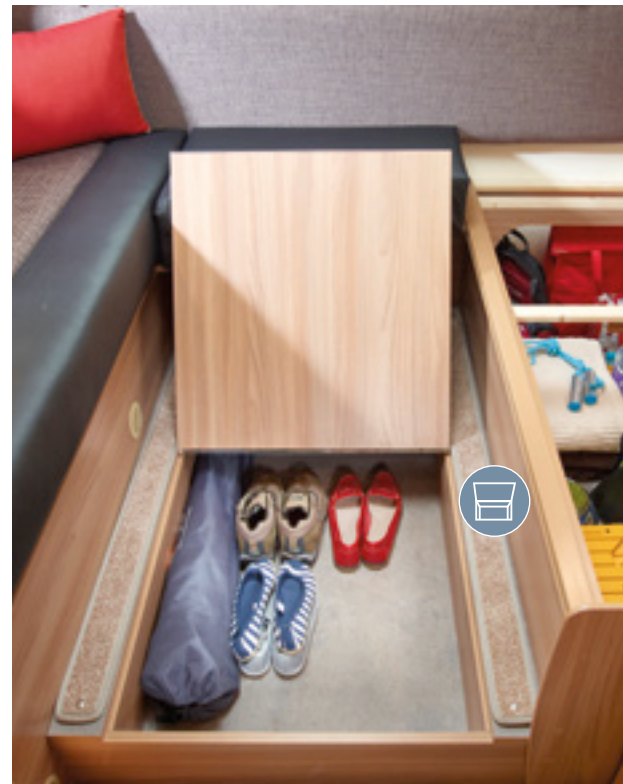

“Enjoying
BREAKFAST
with a
beautiful VIEW.”



Your memories are unique and your Bailey Advance should be too. Your motorhome gives you the opportunity to create your own personalised home from home.

For that extra level of comfort, why not upgrade to the Premium Pack? It includes cab air conditioning, DAB radio with Bluetooth connectivity, USB connection points as well as passenger airbags and removable carpets too. After all, this is your journey, your way.

-  Drop down bed
-  Under-floor storage
-  'Queensway' upholstery fabric

Go to: www.baileyofbristol.co.uk

360°
VIEW

APPROACH
ADVANCE



VEHICLE CONSTRUCTION

PEUGEOT BOXER CAB

- Peugeot fully compliant Euro 6 Boxer Cab supplied with a 3-year/100,000 mile warranty and 12 months Peugeot Assist Cover
- Peugeot 2.0 Blue Hdi (High Pressure Direct Injection) 130bhp engine with six speed manual gear box
- Premium branded tyres with tyre pressure sensors
- Electric cab windows and heated wing mirrors with direction indicators
- Variable power steering
- Anti-lock braking system (ABS)
- Engine immobiliser
- Driver airbag
- Fully adjustable upholstered driver and passenger Captain's seats
- Thermal cab side window covers
- Two 12v sockets
- USB connection point in storage locker
- Twin cup holders

EXTERIOR FEATURES

- Dometic slim line flush fit habitation door with a gas-strut assisted mechanism for smooth operation
- Low level door step with non-slip mat and grab handle
- Mini Heki roof light located over front lounge and kitchen (model specific)
- Midi Heki roof light located over rear lounge or bedroom
- Polyplastic double glazed windows with night latch ventilation

CONSTRUCTION

- Ultra-low profile AL-KO AMC Chassis
- AL-KO AMC Chassis prepared for towbar fitment
- Alu-Tech bodyshell habitation area
- Supplied with a 6-year transferable bodyshell integrity guarantee and a 3-year transferable manufacturer's components warranty*
- 4-year transferable extension to bodyshell integrity guarantee available as a cost option (making 10 years in total)*
- 3-year transferable extension to manufacturer's component warranty available as a cost option (making 6 years in total)*
- BS EN-1646-1 Grade III classification for heating and thermal insulation
- European Whole Vehicle Type Approval
- Structural interlocking aluminium extrusion external framework with no external fixing points for additional strength and rigidity
- Upper body panels manufactured using superior bead application laminating technology for a stronger more consistent bond
- Upper body panels built using a timber free construction, incorporating a composite plastic internal skeleton, a high density polystyrene insulation and a GRP inner wall lining
- Upper body panels cloaked in a single sheet impact resistant GRP outer skin for extra durability
- Strengthened floor panel with GRP underside protection

- Retractable flyscreens and blinds to all principal windows
- Splash proof retractable blinds for kitchen and washroom windows
- Centrally mounted easy access exterior gas locker compartment
- Exterior access storage locker (635, 640)
- Fixing points for rear mounted cycle rack
- Fixing points for exterior ladder and roof rack

Everything
YOU NEED TO
KNOW ABOUT
APPROACH
ADVANCE



*Terms and conditions apply. Please visit www.baileyofofbristol.co.uk for more information.

INTERIOR FEATURES

FURNITURE AND SOFT FURNISHINGS

- Bailey 'Mendip Ash' furniture finish
- Contemporary Italian design overhead lockers
- 'Ash grey' kitchen and washroom worktop finish
- Premium quality fixtures and fittings in polished chrome finish
- Slide out bed boxes for easy bed make up (635 and 640)
- Roller slat mechanism for easy bed make up (615 and 665)
- Sprung beech bed box tops for additional comfort
- Deep-fill bed boxes with enhanced storage capacity
- Automatically operated ceiling mounted drop down double bed with sprung base (665)
- Aluminium frame fixed double bed with gas strut assisted opening mechanism (640)

SERVICES

ELECTRICAL SYSTEM

- 80 ampere/hour premium leisure battery
- Dedicated under floor leisure battery storage locker
- Electrical control panel
- 12v ambient and task lighting fittings throughout
- 230v power supply with up to four interior sockets
- Up to two TV stations with 230v/12v/aerial sockets
- Domestic style consumer unit with dedicated access door
- Switch mode battery charger with 20 amp output
- RCD/MCD protection for mains electric system
- 25 metre mains connecting lead
- Pre-wired for satellite and aerial connection and rear view camera

- Free standing and/or wall mounted table (both in 665)
- Aircraft style overhead locker system with split level storage, domestic style metal hinges and positive door catches
- Structural locker dividers with greater load bearing capacity
- Choice of either 'Pimlico' or 'Queensway' soft furnishings with two scatter cushions and co-ordinating curtains
- Fully sprung upholstery featuring premium quality fabrics, high density filling and superior cushion construction
- De-Luxe sprung double bed mattresses (640)
- Foam filled double bed mattress on a sprung base (665)
- Textured finish durable floor vinyl
- Under floor dedicated storage area suitable for footwear
- Split section loose fit drop in carpets (25oz pile density)

WATER AND HEATING SYSTEMS

- Whale floor mounted 4kw space heater and blown air heating system
- Whale rapid heat water heater
- Whale premium freshwater pump (submersible)
- Pressurised hot and cold fresh water system
- Rigid pipe waste plumbing system
- 90 litre onboard fresh water tank with baffles and level sensor
- 90 litre external waste water tank with baffles and level sensor
- Thetford C-260 cassette toilet with integrated header tank
- Inboard shower unit with ceramic ball mixer tap and Ecocamel shower head
- Fully lined shower cubicle with bi-fold partition door (635, 640)
- Fully lined shower wet room with partition curtain (615, 665)
- Washroom hand basin with ceramic ball mixer tap

SAFETY AND SECURITY

- AL-KO outriggers fitted to AMC Chassis for enhanced floor strength
- 3-point seat belts on all designated travelling seats (615, 665)
- Steel frame seat base supports for all travelling seats (615, 665)
- Steel framed seat base tops with Velcro base cushion fastenings for all designated travelling seats (615, 665)
- Steel framed structural bulkhead to support rear-facing designated travelling seats (665)
- 'Fix and Go' tyre repair kit
- Smoke alarm and carbon monoxide alarm

KITCHEN EQUIPMENT

- Dometic 80 or 103 litre refrigerator with detachable freezer compartment (model specific)
- Thetford Duplex anti-rattle combination oven and grill
- Thetford 3-burner gas hob incorporating flush fitting glass hinged lid and conveniently located controls
- Stainless steel circular kitchen sink with swan-neck mixer tap, circular washing up bowl, drainer and chopping board
- Provision for optional microwave oven

OPTIONAL UPGRADES

FACTORY FIT OPTIONS

- Premium Pack consisting of the following items: cab air conditioning, passenger airbag, Remis concertina windscreen blind, removable cab carpet, DAB Radio with Bluetooth connectivity, USB connection point (located in storage locker beneath the radio) and 2 door speakers.

RETAILER FIT OPTIONS

- Microwave oven
- Co-ordinating bedding set for fixed bed mattresses

	615	635	640	665
Peugeot Engine/Capacity	130bhp/1997cc	130bhp/1997cc	130bhp/1997cc	130bhp/1997cc
Engine Power	130bhp @ 3750rpm	130bhp @ 3750rpm	130bhp @ 3750rpm	130bhp @ 3750rpm
Engine Torque	350Nm @ 1750rpm	350Nm @ 1750rpm	350Nm @ 1750rpm	350Nm @ 1750rpm
Roof Profile	Low Profile	Low Profile	Low Profile	Low Profile
Chassis	AL-KO AMC	AL-KO AMC	AL-KO AMC	AL-KO AMC
Thermal Insulation	3	3	3	3
Designated Travelling Seats	4	2	2	6
Berths	2	2	4	6
Overall Length	5.999m/19'8"	6.632m/21'9"	6.632m/21'9"	6.960m/22'10"
Overall Body Width (Inc marker lights and exc mirrors)	2.346m/7'8"	2.346m/7'8"	2.346m/7'8"	2.346m/7'8"
Overall Height	2.785m/9'2"	2.785m/9'2"	2.785m/9'2"	2.785m/9'2"
Tyre Size	215/70 R15 LI109Q	215/70 R15 LI109Q	215/70 R15 LI109Q	215/70 R15 LI109Q
MTPLM	3500kg/68.9cwt	3500kg/68.9cwt	3500kg/68.9cwt	3500kg/68.9cwt
MRO***	2665kg/52.5cwt	2745kg/54.0cwt	2775kg/54.6cwt	2930kg/57.7cwt
Total User Payload*	835kg/16.4cwt	755kg/14.9cwt	725kg/14.3cwt	570kg/11.2cwt
Max Recommended Braked Trailer Weight	2000kg	2000kg	2000kg	2000kg
Gross Train Weight	5500kg	5500kg	5500kg	5500kg
Fresh Water Tank Capacity	90L	90L	90L	90L
Waste Water Tank Capacity	102L	102L	102L	102L
Gas Locker Capacity**	2 x 3.9kg	2 x 6kg	2 x 6kg	2 x 6kg
Bed Sizes				
Front Double	-	2.055m x 1.860m (6'9" x 6'1")	2.055m x 1.330m (6'9" x 4'4")	1.825m x 0.980m (6'0" x 3'2")
Front N/S Single	-	1.860m x 0.735m (6'1" x 2'5")	-	-
Front O/S Single	-	1.860m x 0.735m (6'1" x 2'5")	-	-
Rear Double	2.055m x 1.335m (6'9" x 4'4")	-	1.910m x 1.340m (6'3" x 4'5")	2.055m x 1.615m (6'9" x 5'3")
Drop Down Double***	-	-	-	1.780m x 1.250m (5'10" x 4'1")

COMPARE
OUR
MOTORHOMES
ONLINE

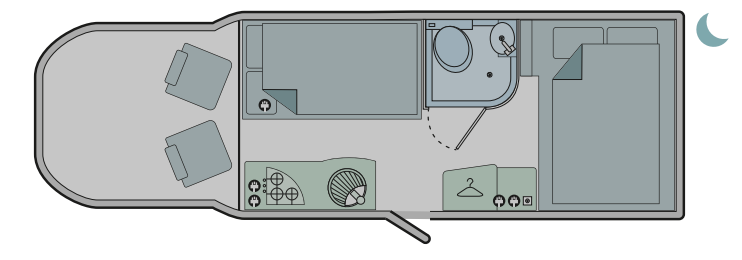
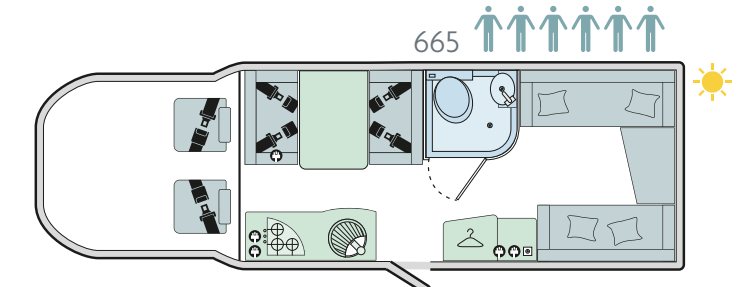
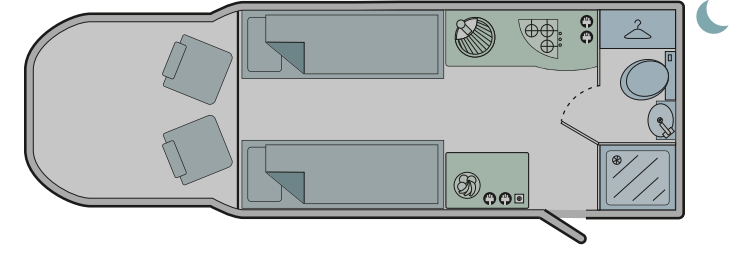
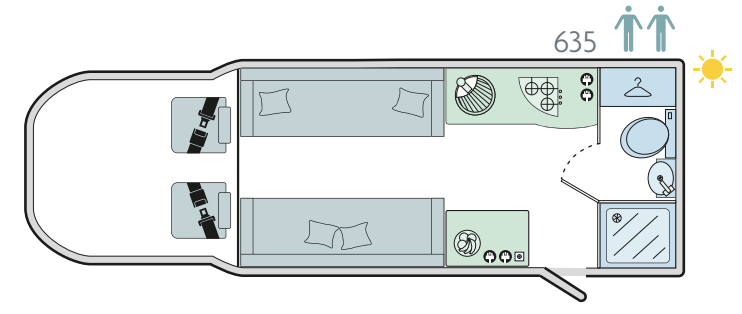
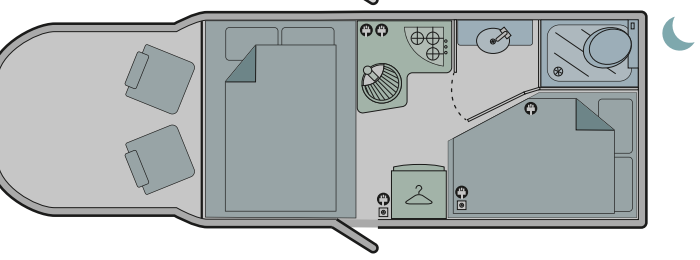
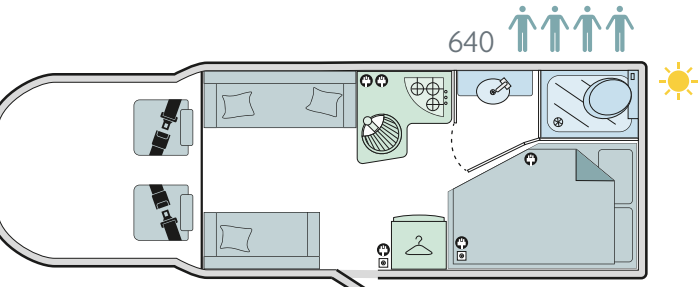
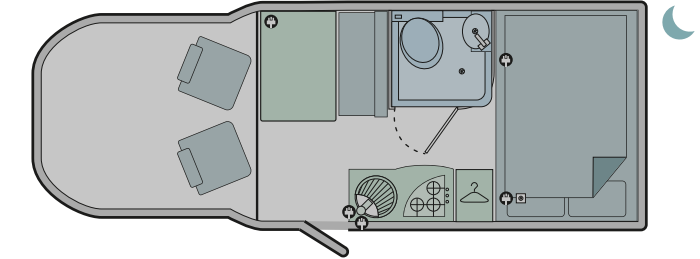
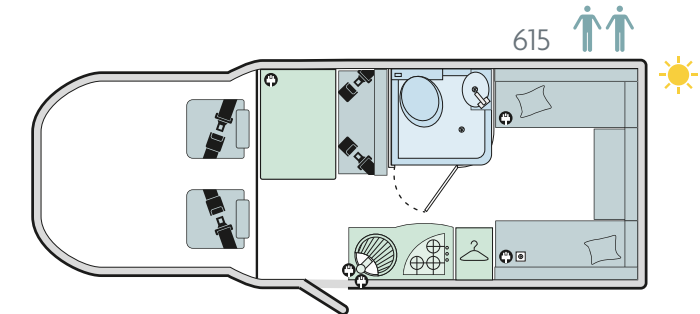



“THE look of determination ON HIS face!”

Make every moment

memorable with a Bailey Autograph

We want every moment of your time away from home to be unforgettable. And with the Bailey Autograph, we've made sure that everything is in place to help you create memories to treasure.

From the sheer pleasure of driving such a responsive and powerful engine, to the convenience of having everything you need for your holiday easily at hand, the Autograph has been designed with the end user in mind.

Whether you're revisiting some favourite corners of the country, exploring pastures new, or even travelling abroad, in an Autograph you'll take all your home comforts with you and make your home wherever you go.

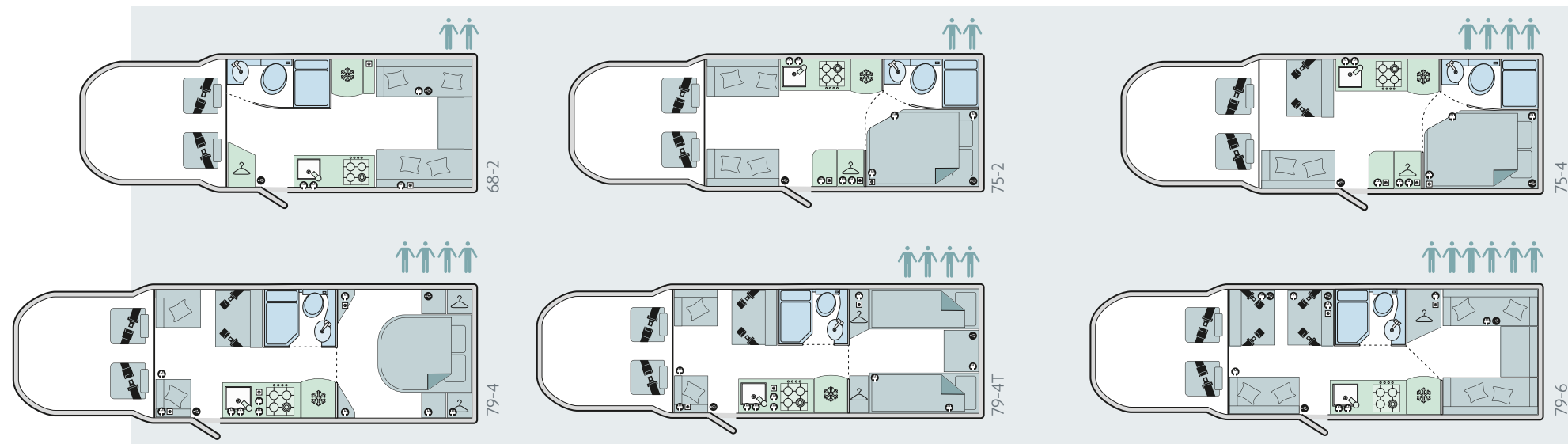
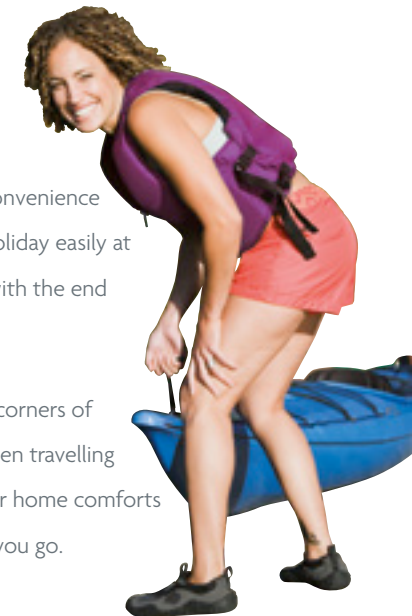



Go to: www.baileyofbristol.co.uk



360° VIEW



“Enjoying A LEISURELY lunch in true COMFORT.”

True luxury is having all the comfort and technology you need, with the space to enjoy it. The ingenious design throughout the Autograph interior creates a real feeling of space and light, without compromising one inch on the home comforts.

From the fully adjustable, upholstered driver and passenger captain's seats to the Alde programmable heating system, we've made sure to surround you in comfort. And with features like a Truma 100W solar panel and a Fiamma F45S wind-out awning, Autograph comes fully equipped with everything you need to make memories aplenty.

-  Heki roof lights throughout
-  Bailey 'Mendip Ash' furniture finish
-  Fully adjustable upholstered driver and passenger seats
-  Single piece, fully sealed shower cubicle
-  Truma 100 watt solar panel
-  Alde programmable heating system









With sleek, contemporary cabinetry and plush furnishings and upholstery throughout, the Autograph is a space you're going to want to spend a lot of time in. So we've made sure you've got everything you need to make every moment magical.

This is our flagship motorhome, so we've pushed the boat out to include a huge range of luxury features as standard. Whether you're grabbing a well-earned weekend break, or you're off on a once-in-a-lifetime adventure, the Autograph comes packed with everything you need to travel well.

“ Spending LONG relaxed afternoons WITH A GOOD BOOK. ”



-  Basalt stone finish, self healing worktop
-  New kitchen units with heavy duty drawers
-  Fiamma F45S wind-out awning
-  Leather fabric upgrade available on both 'Berkeley' and 'Grosvenor' upholstery
-  DreamSleep technology



Autograph

Go to: www.baileyofbristol.co.uk

360° VIEW

Sound AND VISION

“All the excitement of a holiday WITH ALL THE comforts of HOME.”

Just because you're on the open road doesn't mean you should compromise on the entertainment. We worked with specialist sound technicians to create a choice of systems that will blow you away!

You can choose between two optional packs to customise your space, your way. For a small extra charge, our Media Pack comes with a Waeco reversing camera, 19" HD Avtex TV and DVD player, along with a telescopic digital aerial.

While Media Pack Plus bathes you in sound, with speakers in the doors and lounge and even a portable Bluetooth speaker.

Media Pack Plus also gives you all the information you need at your fingertips thanks to a touch-screen head unit. It also includes an additional 24" HD TV and DVD player and a reversing camera to keep you safe.



Branded portable Bluetooth speaker



Upgraded branded lounge speakers



19" HD Avtex TV plus DVD player



6.5" touch-screen head unit



Waeco reversing camera touch-screen head unit in Media Pack Plus

COMFORT YOU dream ABOUT

Our award winning DreamSleep cushion system gives you the best of both worlds. During the daytime, multi-layered cushions and shaped backrests create the same comfort you'd enjoy on the sofa at home.

Then in just a few quick movements, the seats transform into a spacious and luxurious double bed. As the seats are multi-layered you won't need to use the backrests. The bed fabric is fully breathable, so air flows through the system, keeping any moisture at bay.

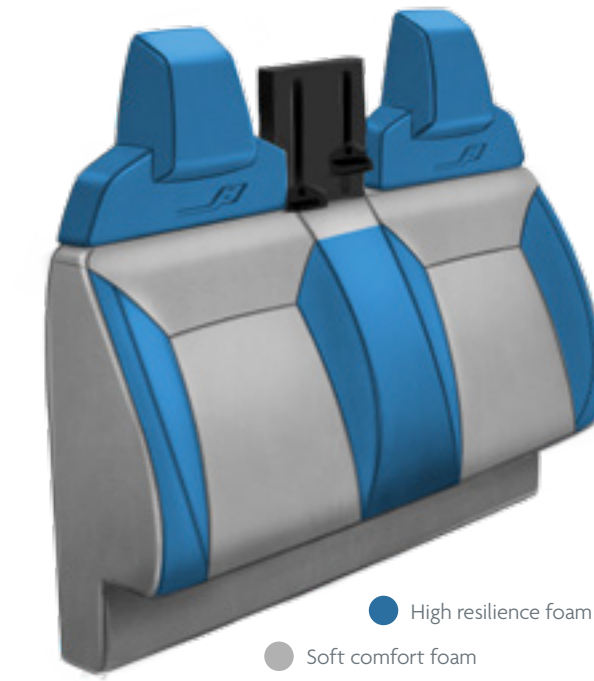

- High resilience foam
- Soft comfort foam

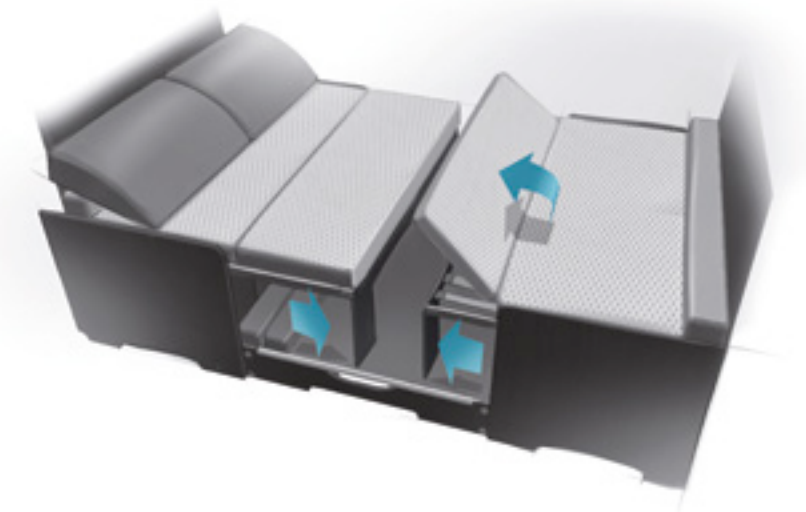



VEHICLE CONSTRUCTION

PEUGEOT BOXER CAB

- Peugeot fully compliant Euro 6 Boxer Cab supplied with a 3-year/100,000 mile warranty and 12 months Peugeot Assist Cover
- Peugeot 2.0 Blue Hdi (High Pressure Direct Injection) 160bhp engine with six speed manual gear box
- Premium branded tyres with tyre pressure sensors
- Remote central locking for cab and habitation door
- Electric cab windows and heated wing mirrors with direction indicators
- Variable power steering
- Electronic Stability Program (ESP)
- Anti-lock braking system (ABS)
- Engine immobiliser
- Cab air conditioning and cruise control
- Driver and front passenger airbags
- Fully adjustable upholstered driver and passenger Captain's seats with twin armrests and integrated headrests
- Concertina windscreen and side window blinds
- DAB Radio with Bluetooth connectivity and 2 door speakers
- Two 12v sockets and USB connection point in storage locker
- Twin cup holders

CONSTRUCTION

- AL-KO AMC Chassis
- 'Fix and Go' tyre repair kit
- Alu-Tech bodyshell habitation area
- Supplied with a 6-year transferable bodyshell integrity guarantee and a 3-year transferable manufacturer's components warranty*
- 4-year transferable extension to bodyshell integrity guarantee available as a cost option (making 10 years in total)*
- 3-year transferable extension to manufacturer's component warranty available as a cost option (making 6 years in total)*
- BS EN-1646-1 Grade III classification for heating and thermal insulation

- European Whole Vehicle Type Approval
- Structural interlocking aluminium extrusion external framework with no external fixing points for additional strength and rigidity
- Upper body panels manufactured using superior bead application laminating technology for a stronger more consistent bond
- Upper body panels built using a timber free construction, incorporating a composite plastic internal skeleton, a high density polystyrene insulation and a GRP inner wall lining
- Strengthened floor panel with GRP underside protection



EXTERIOR FEATURES

- 'Aero Style' rear bumper and light pillars with LED road lights
- Fiamma F45S wind-out awning
- Dometic slim line flush fit habitation door with window, blind and bin plus a gas-strut assisted mechanism for smooth operation
- Dometic pleated full length door flyscreen
- Low level door step with non-slip mat and grab handle
- Double glazed windows throughout
- Double glazed opening sky view over cab window with blind
- Large Heki roof light over front lounge (model specific) and kitchen
- Large Heki roof light located over rear lounge or bedroom
- Pleated flyscreens and night blinds to all principal windows
- Splash proof roller blinds for kitchen window
- Centrally mounted exterior gas locker compartment with flush fit double seal exterior locker door featuring heavy duty handles, two compression locks and retaining clip
- Propane/Butane en-route gas 30mb regulator mounted in gas locker compartment
- Underbed storage area with flush fit double seal exterior access door with two compression locks and retaining clip (75-2,75-4)
- Through-boot storage area with flush fit double seal exterior access door with two compression locks and retaining clip plus one 230v socket and dedicated light (79-4,79-4T)
- Through-boot storage area with flush fit large double seal exterior access door with two compression locks and retaining clip (79-6)

- Exterior 230v power inlet
- Exterior gas BBQ point
- Vision Plus satellite connection provision
- Fixing points for rear mounted cycle rack
- Diffuser at base of rear bumper for optional towbar fitment



INTERIOR FEATURES

FURNITURE AND SOFT FURNISHINGS

- Bailey 'Mendip Ash' furniture finish
- Contemporary design high gloss dual finish overhead lockers
- Satin finish soft-close drawers with push button handles in kitchen
- Satin finish locker doors and vanity units in washroom
- 'Aero Style' overhead locker system with split level storage, gas struts, domestic style metal hinges and push open locker doors
- Electrical control panel interface with USB socket
- 'Basalt stone' finish kitchen and washroom worktop laminate
- Drop-down kitchen worktop extension (75-2,79-4,79-4T,79-6)
- Domestic standard kitchen units featuring durable worktop surfaces and heavy duty drawers with positive catches
- Premium quality fixtures and fittings in brushed steel finish
- Slide out bed boxes for easy bed make up
- Sprung beech bed box tops for additional comfort
- Drop down flaps on front bed box fascias for (75-2,75-4,79-6)
- Deep-fill bed boxes with enhanced storage capacity (79-6)

Everything YOU NEED TO KNOW ABOUT Autograph

- Fixed double beds with gas strut assisted opening mechanism (75-2,75-4, 79-4)
- Fixed single beds with gas strut assisted opening mechanism (79-4T)
- Ceiling mounted mechanically operated Alu-Line transverse drop down double bed with sprung base (79-6)
- Floor mounted table with dedicated stowage (75-4,79-4,79-4T)
- Free standing and wall mounted table with dedicated stowage (79-6)
- Free standing table with dedicated stowage (75-2)
- 'DreamSleep' multi-layered lounge seat base cushions for enhanced comfort and easier bed make-up
- 'DreamSleep' domestic style lounge backrests for enhanced comfort
- Foam filled upholstery with quality fabrics and high density filling
- Choice of either 'Berkeley' or 'Grosvenor' soft furnishings with two scatter cushions, decorative window panels and roman window blinds
- 'DreamSleep' mattress with honeycore foam construction and breathable antibacterial ultimate freshness fabric
- Fully lined curtains in dedicated bedrooms (75-2,75-4,79-4,79-4T)
- Textured finish durable floor vinyl
- Split section loose fit drop in carpets (50oz pile density)



SERVICES

ELECTRICAL SYSTEM

- Truma 100 watt solar panel
- 110 ampere/hour premium leisure battery

- Dedicated under floor twin leisure battery storage locker
- Electrical control panel
- 12v ambient and task light fittings throughout
- Additional ambient over locker lighting
- Additional low level task lighting
- 12v shower cubicle lighting
- 230v power supply with up to eight new design interior sockets
- Up to three USB sockets
- Up to two TV stations with 230v/12v/aerial sockets
- Switch mode battery charger with 20 amp output
- RCD/MCD protection for mains electric system
- Pre-wired for satellite, aerial connection and rear view camera

WATER AND HEATING SYSTEMS

- Alde Hydronic Compact 3020 programmable radiator heating system with combined water heating
- Touch screen user-friendly control panel
- Dual fuel 3.4 Kw gas and 3 Kw electric power sources
- Programmable daily timer
- Panel radiator in washroom
- Panel radiator in living area (79-4,79-4T,79-6)
- Whale Aqua smart II on-board water with Aquasource 'lay flat' filling pipe
- Pressurised hot and cold fresh water system and self-priming pump
- Rigid pipe waste plumbing system
- 93.5 litre external insulated water tank with baffles and level sensor
- Fresh water tank heater for winter protection and overflow
- 93.5 litre external waste water tank with baffles and level sensor
- 12v electric flush toilet with removable cassette on wheels
- Shower with ceramic ball mixer tap and Ecocamel shower head
- Single piece fully sealed shower cubicle
- 'Granite stone' finish shower cubicle with concertina partition door
- Pedestal washroom hand basin with ceramic ball mixer tap
- Retractable clothes line



KITCHEN EQUIPMENT

- Dometic 133 litre tower refrigerator and detachable full width freezer compartment
- Thetford Duplex XL combined oven and grill with electronic ignition and flame failure device
- Thetford dual-fuel hob with electric hotplate and 3 gas burners
- Stainless steel 800 watt microwave oven
- Stainless steel square kitchen sink with swan-neck mixer tap, drainer and chopping board



SAFETY AND SECURITY

- AL-KO outriggers fitted to AMC Chassis for enhanced floor strength
- Ergonomically shaped rear travel seats (75-4,79-4,79-4T,79-6)
- Steel frame seat base supports for all travelling seats (75-4,79-4,79-4T,79-6)
- Steel framed seat base tops for all travelling seats (75-4,79-4,79-4T,79-6)
- Steel framed structural bulkhead to support rear-facing designated travelling seats (79-6)
- 'Fix and Go' tyre repair kit
- Smoke alarm and carbon monoxide alarm
- 3-point seat belts on all travelling seats



OPTIONAL UPGRADES

- 15" or 16" graphite alloy wheels (model specific)
- Factory fitted Media Pack: Waeco reversing camera and screen, Status 550 telescopic directional digital television aerial, 19" HD Avtex digital television with DVD player (12v or 230v)
- Factory fitted Media Pack Plus: Branded 6.5" touch-screen head unit with motorhome specific sat nav, 24" HD Avtex digital television with DVD player and all of the items listed in the standard media pack above, plus portable Bluetooth awning speakers

Autograph

	68-2	75-2	75-4	79-4	79-4T	79-6
Peugeot Engine/Capacity	160bhp/1997cc	160bhp/1997cc	160bhp/1997cc	160bhp/1997cc	160bhp/1997cc	160bhp/1997cc
Engine Power	160bhp @ 3750rpm	160bhp @ 3750rpm	160bhp @ 3750rpm	160bhp @ 3750rpm	160bhp @ 3750rpm	160bhp @ 3750rpm
Engine Torque	350Nm @ 1750rpm	350Nm @ 1750rpm	350Nm @ 1750rpm	350Nm @ 1750rpm	350Nm @ 1750rpm	350Nm @ 1750rpm
Roof Profile	Low Profile	Low Profile	Low Profile	Low Profile	Low Profile	Low Profile
Chassis	AL-KO AMC	AL-KO AMC	AL-KO AMC	AL-KO AMC	AL-KO AMC	AL-KO AMC
Thermal Insulation	3	3	3	3	3	3
Designated Travelling Seats	2	2	4	4	4	6
Berths	2	2	4	4	4	6
Overall Length	6.794m/22'3"	7.509m/24'7"	7.509m/24'7"	7.988m/26'3"	7.988m/26'3"	7.988m/26'3"
Overall Body Width†	2.489m/8'2"	2.489m/8'2"	2.489m/8'2"	2.489m/8'2"	2.489m/8'2"	2.489m/8'2"
Overall Height	2.769m/9'1"	2.782m/9'2"	2.782m/9'2"	2.769m/9'1"	2.769m/9'1"	2.769m/9'1"
Tyre Size	215/70 R15 CP LI109R	215/70 R15 CP LI109R	215/70 R15 CP LI109R	215/70 R15 CP LI109R	215/70 R15 CP LI109R	225/75 R16 CP 116/114 Q M+S
MTPLM	3500kg/68.9cwt	3500kg/68.9cwt	3500kg/68.9cwt	3850kg/75.8cwt	3850kg/75.8cwt	4250kg/83.7cwt
MRO	3049kg/60cwt	3185kg/62.7cwt	3145kg/61.9cwt	3366kg/66.3cwt	3392kg/66.8cwt	3457kg/68.0cwt
Total User Payload	451kg/8.9cwt	315kg/6.2cwt	355kg/7.0cwt	484kg/9.5cwt	458kg/9.0cwt	793kg/15.6cwt
Max Rec. Braked Trailer Weight	2000kg	2000kg	2000kg	1650kg	1650kg	1750kg
Gross Train Weight	5500kg	5500kg	5500kg	5500kg	5500kg	6000kg
Fresh Water Tank Capacity	93.5L	93.5L	93.5L	93.5L	93.5L	93.5L
Waste Water Tank Capacity	93.5L	93.5L	93.5L	93.5L	93.5L	93.5L
Gas Locker Capacity*	2 x 6kg	2 x 6kg	2 x 6kg	2 x 6kg	2 x 6kg	2 x 6kg
Fitted Awning Length	3.5m	4m	4m	4.5m	4.5m	4.5m
Bed Sizes						
Front Double	-	2.15m x 1.30m (7'1" x 4'3")	2.20m x 1.30m (7'3" x 4'3")	1.70m x 1.02m (5'7" x 3'4")	1.70m x 1.02m (5'7" x 3'4")	1.70m x 1.02m (5'7" x 3'4")
Front N/S Single	-	-	-	-	-	-
Front O/S Single	-	-	-	-	-	-
Rear Double	2.12m x 1.56m (6'11" x 5'1")	1.90m x 1.30m (6'3" x 4'3")	1.90m x 1.30m (6'3" x 4'3")	1.90m x 1.40m (6'3" x 4'7")	-	2.12m x 1.58m (6'11" x 5'2")
Rear N/S Single	-	-	-	-	1.92m x 0.76m (6'3" x 2'6")	-
Rear O/S Single	-	-	-	-	1.84m x 0.76m (6'0" x 2'6")	-
Drop Down Double**	-	-	-	-	-	2.01m x 1.25m (6'7" x 4'1")

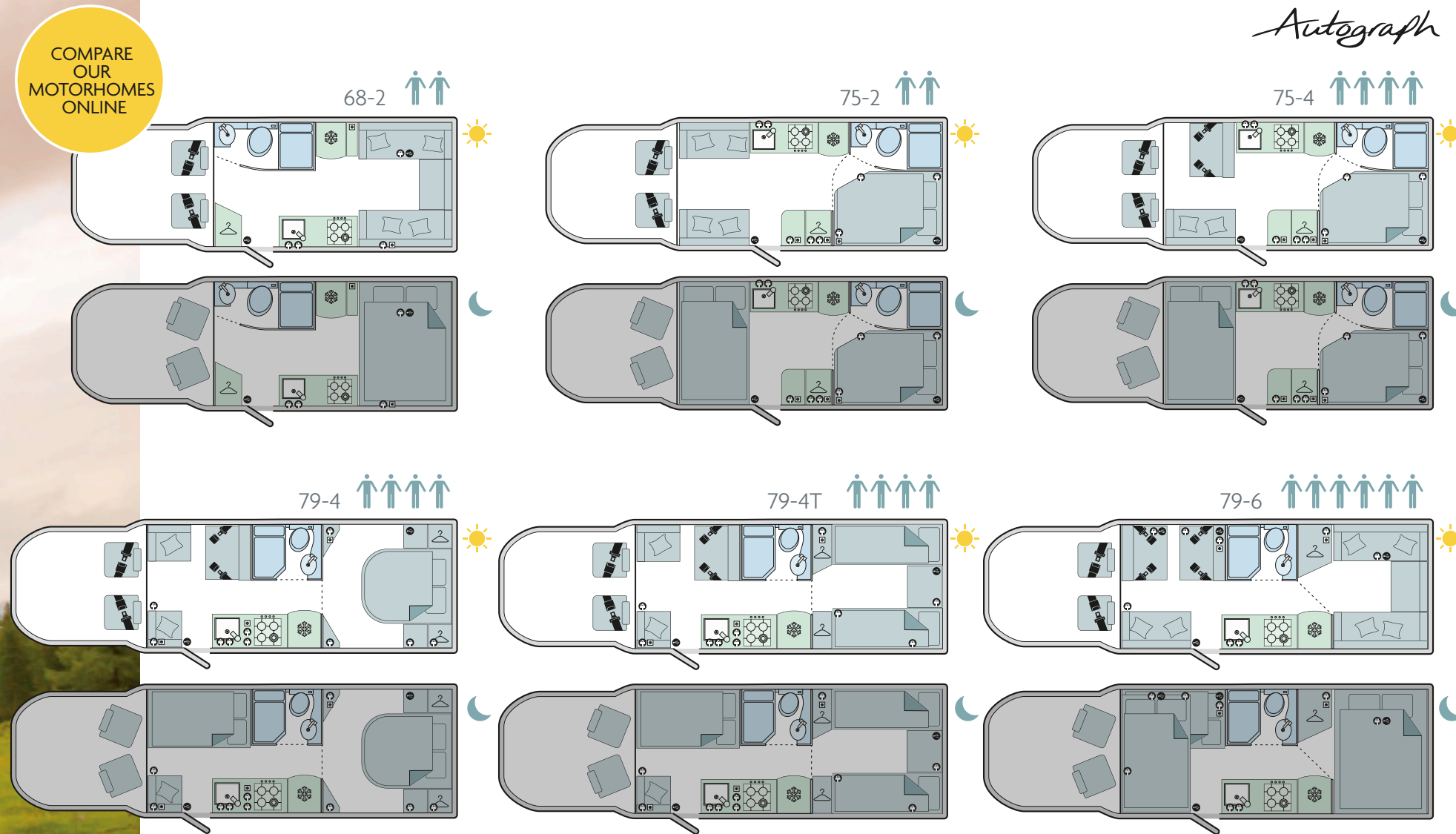



A *pleasure* TO DRIVE



Crash testing

At Bailey we never compromise on comfort. So our motorhome cabs are as comfortable as the living space behind them. Each vehicle in the range is powered by a 2.0 Blue Hdi 130bhp or 160bhp engine, along with a 6-speed manual gearbox. That means powerful performance for the journey and easy handling for you.

This is a cab where you can feel safe and secure. This is thanks to the ultra-low profile AL-KO AMC chassis which creates a low centre of gravity, making handling easier and braking more efficient. Getting in and out of the cab is easier too, thanks to the low-level entrance step. All our motorhomes come with driver airbags as standard, plus, all Autographs have passenger airbags, Air Con and cruise control too. A passenger airbag and Air Con are available as optional extras on Advance.



Choices, choices WHICH MOTORHOME SUITS YOU?

Our handy comparison table helps you choose the right model, to make wonderful memories that last a lifetime.



APPROACH ADVANCE

EXTERNAL FEATURES

Alu-Tech bodyshell construction with GRP outer skin
Peugeot Euro 6 Boxer Cab
Peugeot 2.0 Hdi 130bhp engine
Premium branded tyres with pressure sensors

OPTIONAL EXTRAS

Anti-lock braking system (ABS)
Electronic Stability Program (ESP)
Driver air bag

Passenger airbag*
Cab air conditioning*

Fully adjustable upholstered driver and passenger Captain's seats
Thermal cab side window covers

Concertina windscreen blind*

DAB Radio with Bluetooth connectivity*

Ultra low profile AL-KO AMC Chassis

INTERNAL FEATURES

80 Ah premium leisure battery
90 litre onboard fresh water tank
90 litre exterior waste water tank
Whale space heater and blown air heating system
Dometic 80 or 103 litre refrigerator and detachable full width freezer compartment

Stainless steel 800 watt microwave oven

Thetford duplex anti-rattle combination oven and grill
Thetford 3-burner gas hob incorporating flush fitting glass hinged lid
Up to four 230v sockets

Choice of Pimlico or Queensway soft furnishing options

Co-ordinating bedding sets



Autograph

EXTERNAL FEATURES

Alu-Tech bodyshell construction with GRP outer skin
Peugeot Euro 6 Boxer Cab
Peugeot 2.0 Blue Hdi 160bhp engine
Premium branded tyres with pressure sensors

OPTIONAL EXTRAS

Anti-lock braking system (ABS)
Electronic Stability Program (ESP)
Driver and passenger airbag

15" or 16" wheels (model specific)

Cab air conditioning and cruise control

Fully adjustable upholstered driver and passenger Captain's seats

Concertina windscreen and side window blinds

DAB Radio with Bluetooth connectivity

Ultra low profile AL-KO AMC Chassis

Fiamma F45S aero style awning

Truma 100 watt solar panel

Exterior gas BBQ point

INTERNAL FEATURES

110 Ah premium leisure battery
93.5 litre onboard fresh water tank
93.5 litre exterior waste water tank
Alde programmable radiator heating system
Dometic 133 litre tower refrigerator and detachable full width freezer compartment

Stainless steel 800 watt microwave oven

Thetford duplex XL combination oven and grill
Thetford 3-burner gas hob incorporating flush fitting glass hinged lid with electric hotplate

Up to eight 230v sockets

Up to three USB sockets

Choice of Berkeley or Grosvenor soft furnishing options

Leather fabric upgrade

Co-ordinating bedding sets

Media Pack †

Media Pack Plus†

*Available as part of a Premium Pack consisting of: Cab air conditioning, passenger airbag, concertina windscreen blind, removable cab carpet, DAB radio with Bluetooth connectivity.

† Full details of contents on page 25.

A LITTLE BIT ABOUT BAILEY

It's a big *family* adventure!

We love holidays! That's why we go the extra mile to make sure that our customers have some truly memorable experiences. Whatever motorhome you travel in, we're here to provide all the equipment and support you need to make every holiday a success.

The Bailey journey began in 1948, when Martin Bailey started designing and building caravans in his garage in south Bristol. Martin wanted to make vehicles that he himself would love to holiday in.

Martin's first caravans struck a chord with holidaymakers across the UK and Bailey became a thriving family-run business. Since those early days, we've helped tens of thousands of families get out there and create some lasting memories to treasure.



Bailey is still a family business today, run by people that are equally as passionate about helping create the perfect holiday for you.

Through our wealth of experience in leisure vehicle production and design, we're inspiring a whole new generation of people to make memory after memory in our vehicles.

Our *precious* MEMORIES from 1948 to 2017...





DESIGNED WITH YOU IN MIND

The best design starts with *people*

A designer needs to know what people want. What they'd like to change. And what they'd love to see.

We regularly involve our customers and get their feedback on our designs. That way we can make sure that every new model or redesign ticks all the boxes to create an ideal home from home.



Once we're confident we know what you want, we thoroughly evaluate every element of our new designs through one of the industry's most comprehensive test programmes. By seeing how our products perform in places as diverse as the Swiss Alps and the Australian Outback, we can be sure that they are capable of taking you on your own adventure.

The design dream team

To create the ideal motorhome takes teamwork. Our designers work closely with some of Europe's leading manufacturers to source the components that make every Bailey truly special. As a result, all our motorhomes are built on an AL-KO AMC ultra-low profile lightweight chassis and Alu-Tech bodyshell and are fitted with Alde or Whale heating systems, Dometic refrigerators and Thetford ovens. Only the best is good enough for Bailey.

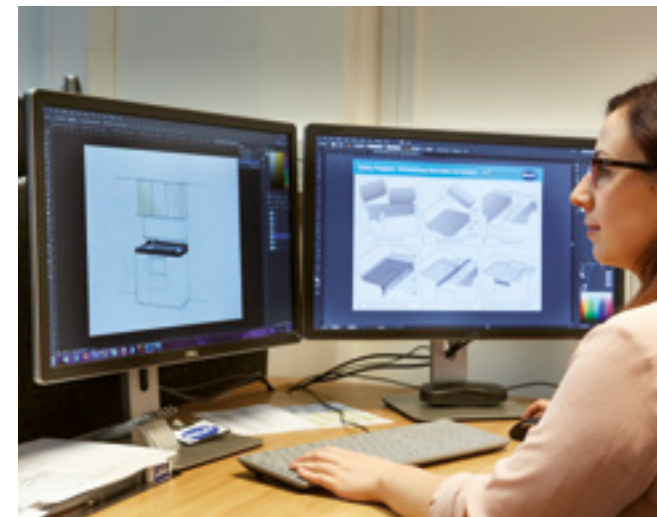

MANUFACTURING IN BRISTOL

Leading the way in manufacturing



Perhaps it comes from those wide open horizons out on the road, but at Bailey we're known for our blue sky thinking. Take our factory, for example. We've mechanised our production line to make sure our technicians can spend their time working on the vehicles rather than having to manhandle them around the plant. That means we can keep our manufacturing costs down and pass on the savings to you, our customers.



WE'RE SO
proud
OF OUR FACTORY...

Bailey
Owners Club

Join the BOC to enjoy exclusive tours of our factory and meet the people who designed and built your motorhome.

We've been clever with our parts too. By keeping our component stock levels to a minimum we bring our overheads down and make manufacturing more efficient. Again, that means we pass on great value to you.

Our skilled technicians take real pride in what they do. We do not incentivise them to work faster, instead we encourage them to take their time and focus on making each motorhome as good as it can be.



OUR TECHNOLOGY

A Alu-Tech
Bodyshell

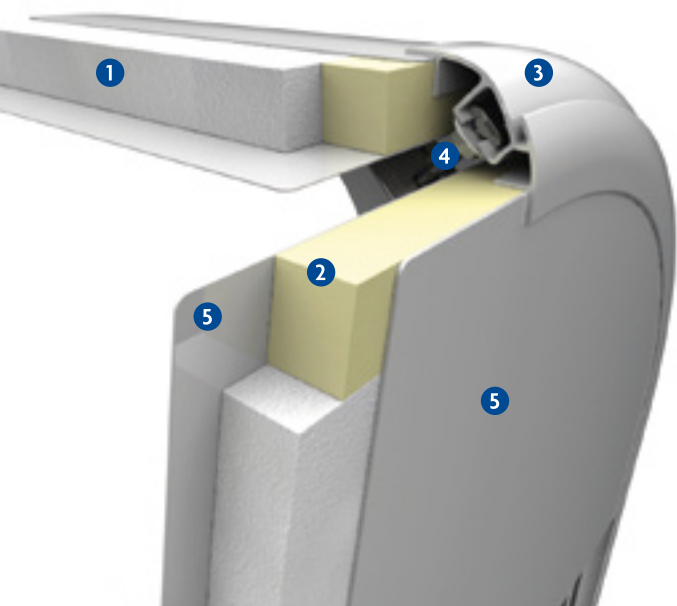

Alu-Tech means you *can*

You want your motorhome to be a real home from home and we quite agree. That's why we incorporate the latest design technology into our vehicles to ensure every holiday you take is a pleasure.

Leading the way

Our Alu-Tech bodyshell is seen by many as the most important development in leisure vehicle design in recent times. We wanted a construction system which made motorhomes more robust and durable than existing vehicles, to keep owners comfortable, safe and secure all year round.

Features of Alu-tech

- 1 High density polystyrene core
- 2 Composite plastic extrusion
- 3 Bespoke Alu-Tech rail
- 4 Structural fixing bracket
- 5 GRP (Glass Reinforced Plastic) outer and inner skin

SUPER STRONG AND
robust
TO KEEP YOU SAFE.
You can rely on our
Alu-Tech technology



To meet this challenge, our designers created something truly ground-breaking. A patented aluminium external framework clamps the bodyshell panels together to create a shell that is so much stronger than anything that has gone before. Fewer external joints and fixing points make this shell more weather proof, while significantly thicker panels provide better insulation to keep you warm in the winter and cool in the summer.

When you consider these benefits have been achieved without a price or weight penalty, you can begin to see why Alu-Tech motorhomes are so special.



“Snuggling
up, sharing
A STORY.”

BAILEY PARTS AND ACCESSORIES

Be *prepared* for every journey

Once you've bought a Bailey caravan or motorhome, you'll feel part of the family. So if you ever want a hand finding some new parts or accessories to make your travels even more enjoyable, just get in touch.

www.baileyparts.co.uk is open seven days a week, all year round. Plus, with next day delivery there really is no better place to shop online.

You can also find parts and accessories at our pioneering Bailey click and collect centre in north Bristol. We're pretty sure you'll be impressed with such a great retail experience.

Unit 600,
The Quadrant,
Ash Ridge Road,
Bristol, BS32 4QA.
Call us on
0344 326 4000.

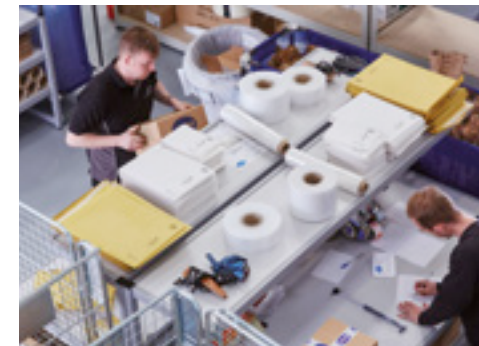

OVER
15,000
parts and accessories
ONLINE
24/7



HOW TO **BUY** A BAILEY...

Closer than you think

The next step is to find out a little bit more. We have a network of approved retailers across the country that we trust to sell our motorhomes. We choose to work with partners who we believe to be the best, so by visiting your nearest Bailey retailer you can be sure you'll be talking to an expert.

Experience Bailey for yourself

There you'll be able to view a wide choice of both new and pre-owned Bailey motorhomes*, in which you can spend time in order to decide what model best suits your needs.

*Subject to availability

**Terms and conditions apply. Please refer to www.baileyofbristol.co.uk for more details

When it comes to making the final decision, there are various finance options available to you, in order to make your purchase more affordable. Feel free to ask at your local retailer if you'd like to know more.

Your
memories
start here!

The Bailey warranty

When you're buying a new Bailey, your motorhome will come with all the reassurance of our manufacturer's warranty. Your motorhome's bodyshell is covered with a 6-year integrity guarantee, while other parts and components are covered for up to 3 years**. Whether you're new to motorhomes or you're a seasoned traveller, that gives you some excellent peace of mind when you're out on the open road.

FIND
YOUR
RETAILER
ONLINE



Interested
TO FIND OUT MORE?

Speak to your local retailer today!



JOIN THE CLUB

If you're *already* an owner

Once you've purchased a Bailey you're already part of an exclusive club. So why not go one step further and join the real thing?

The Bailey Owners Club is completely independent from Bailey of Bristol and is designed to help people get the best out of their Bailey caravan or motorhome. There are members all over the world and there's even a 'Little Bees' section for younger holidaymakers!

Join the club and you'll receive invitations to low-cost weekend events and rallies across the UK, often at exclusive venues. Plus discounts on longer holidays in the UK and abroad, as well as online discounts at www.baileyparts.co.uk. You'll even have a unique chance to come and tour the Bailey factory to meet the people who created your motorhome.



We hope you'll *love* motorhome holidays as much as we do!

Looking for more information?

Find everything you need to know at www.baileyofbristol.co.uk



This brochure does not constitute an offer by Bailey Caravans Ltd (Bailey). Bailey reserves the right to alter specifications and prices as market and supply conditions demand. Your Bailey retailer will confirm all specification details prior to you making your purchasing decision. E. & O. E. Bailey retailers sell our products of their own choice and not as agents of Bailey. Accordingly they have no authority to bind Bailey or to make any representation or undertaking whatsoever on behalf of Bailey. All household items illustrated in this brochure are used to enhance photography and are for display purposes only. They are not supplied with your motorhome. Photographic colour reproduction is subject to the limitations of the production process.

Photography: Alan Bond | Printed February 2017



Connect with us!
We'd love to hear from you:

